

65W/12V Desktop Power Adapter(With Certification) (GWS-AP65-12C)



Features



- Power Input: AC90~264V
- Support production for short circuit/over current/over voltage
- Wide operating ambient temp (-20°C~65°C)
- 100% full load aging test
- High efficiency, long life time and high reliability
- No fan, completely tranquil work
- 3 years warranty

Technical Specification

Model		GWS-AP65-12C	
Output	Group Of Output		1
	DC Voltage		12VDC
	Default Output Voltage		0-5.5A
	Ripple Noise	0<Ta≤55°C	≤50mVp-p
		-15≤Ta≤0°C	≤100mVp-p
	Stabilized Voltage Precision		±1%
	Line Regulation		±1%
	Load Regulation		±1%
	Temperature Coefficient		±0.03%/°C
	Output Start Time		≤3.0S (120Vac input, Full load); ≤2.0S (220Vac input, Full load)
Output Hold Time		≥10mS(120Vac input, Full load); ≥20mS(220Vac input, Full load)	
Voltage Overshoot		<5.0%	
Input	Input Voltage Range		90VAC~264VAC
	Input Rated Voltage Range		100VAC~240VAC
	Frequency Range		47Hz~63Hz
	Efficiency		85%
	Input Current		<0.7A
	Inrush Starting Current		<40A@300Vac Cold start;
	Leakage Current		input to output less than 0.25mA
Protection	Output	Over Power	54~97.5W Swing machine (Testing method: Increase the output current until enabling the protection. Protection mode:Swing machine, Self-recovery after over-power released.)
		Over Voltage	15-10V Swing machine (Short circuit the Pin1-2 of U8, swing machine. Output recovery to normal after removing the short circuit) Note: Do not use external voltage.
		Over Current	6.5~8.8A Swing machine (Testing method: Increase the output current until enabling the protection. Protection mode:Swing machine, Self-recovery after over-current released.)

	Short Circuit	It can be short circuited for a long time and automatically recover after the short circuit is eliminated.
Operation Environment	Operation Temperature And Humidity	-20°C~65°C; 20%~90%RH No condensing
	Storage Temperature And Humidity	-40°C~85°C; 5%~95%RH No condensing
Certification	3C.CE.	
	FCC.EMI/EMC	
Safety And EMC Standard	Security Standard	GB4943/EN60950
	Dielectric Strength	Input—Output:3KVac/10mA; Input--Case:1.5KVac/10mA; Output---Case:0.5KVDC/10mA Time for each testing is 1min.
	Insulation Resistance	Input-Output: 100M ohms; Input-Case: 100M ohms; Output-Case: 100M ohms;
	Electromagnetic Interference	EN55022 Class A
	Harmonic Current	IEC61000-3-2 class A equipment requirements
	Electromagnetic interference Immunity	EN61000-4-2,4,5,6,8,11 ENV50204, class A heavy industry standard
Others	Design MTBF	100,000Hrs AT 25°C, MIL-217 Method 2 Components Stress Method
	Product size(L*W*H)	125*51*32mm
Notes	<p>If the specification is not specified, all specifications and parameters shall be measured at rated input, rated load and 25 C ambient temperature.</p> <p>Ripple noise test method: the use of a 12# twisted pair, while the terminal to parallel capacitance of 0.1uF and 10uF, measured at the scope of the oscilloscope 20MHz bandwidth.</p> <p>The power supply will be installed on the final equipment as a component, and the final equipment will still have to meet the EMC condition.</p>	

Dimension

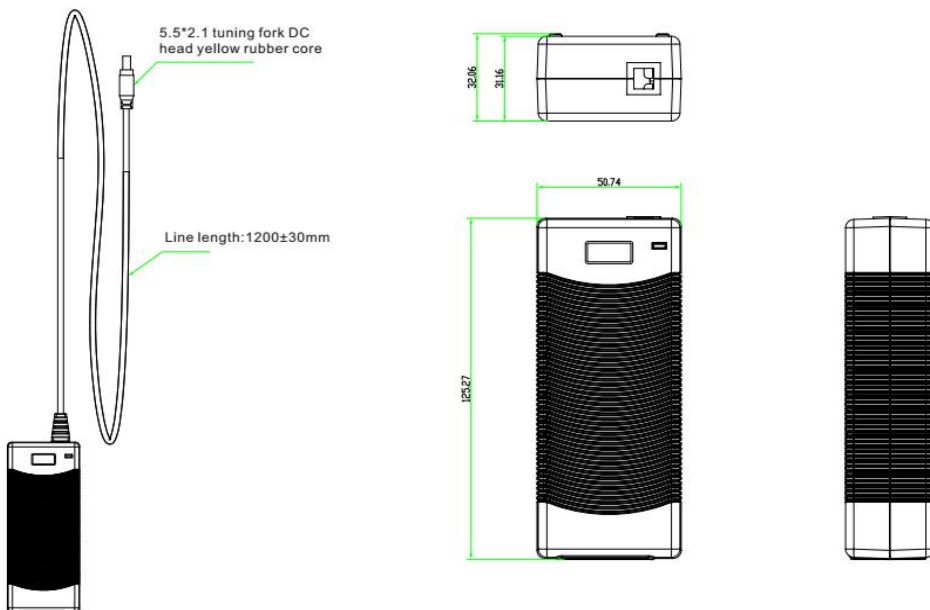

Block Diagram

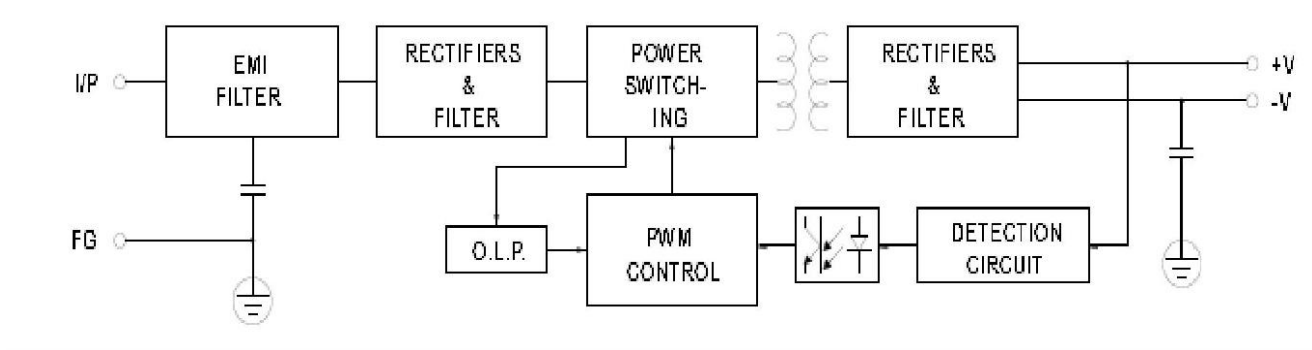

Derating Curve

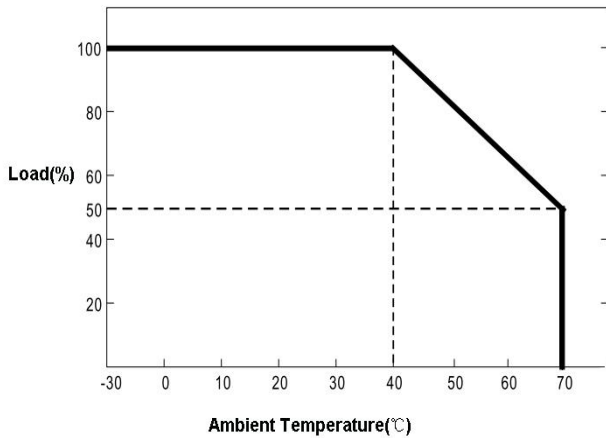

Static Characteristic Curve

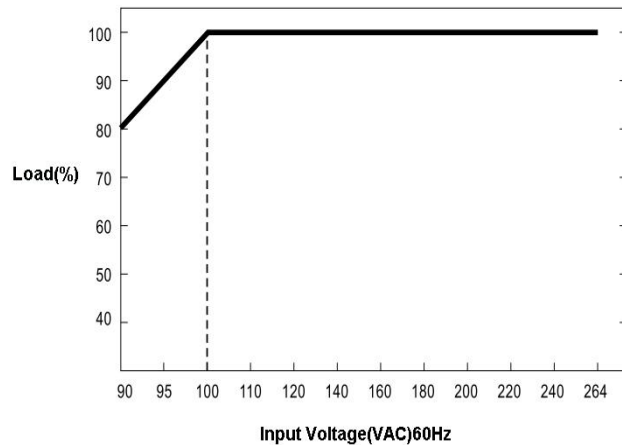

Contact US



Tel: 0086-755-33376606

Fax: 0086-755-33376608

Email: onv@onv.com.cn

Website: www.gwsdz.com/

Zip: 518000

Headquarter Address: Room 1003, Block D, Terra Building, Futian district, Shenzhen, China

Factory Address: The 4-6th Floor, A building, SenYuTai (Science&Technology) Park, HuaNing Road, Dalang sub-district, Longhua district, Shenzhen, China